



UN\_893

## Contents

1. Product Description.....	2
2. Specifications.....	3
3. Safety features .....	4
4. Attributes .....	4
5. Additional Options.....	4
6. Technical Designs .....	5
6.1. Minimum Dimensions 900 x 1200 mm.....	5
6.2. Standard Dimensions 1100 x 1400 mm.....	6
6.3. Max Dimensions 1300 x 1600 mm .....	7
6.4. 90° Entrance – Exit 1100 x 1400 mm.....	8
6.5 3 - d Representations 7. Dimensions of cabinet .....	8

UN\_893

# 1. Product Description

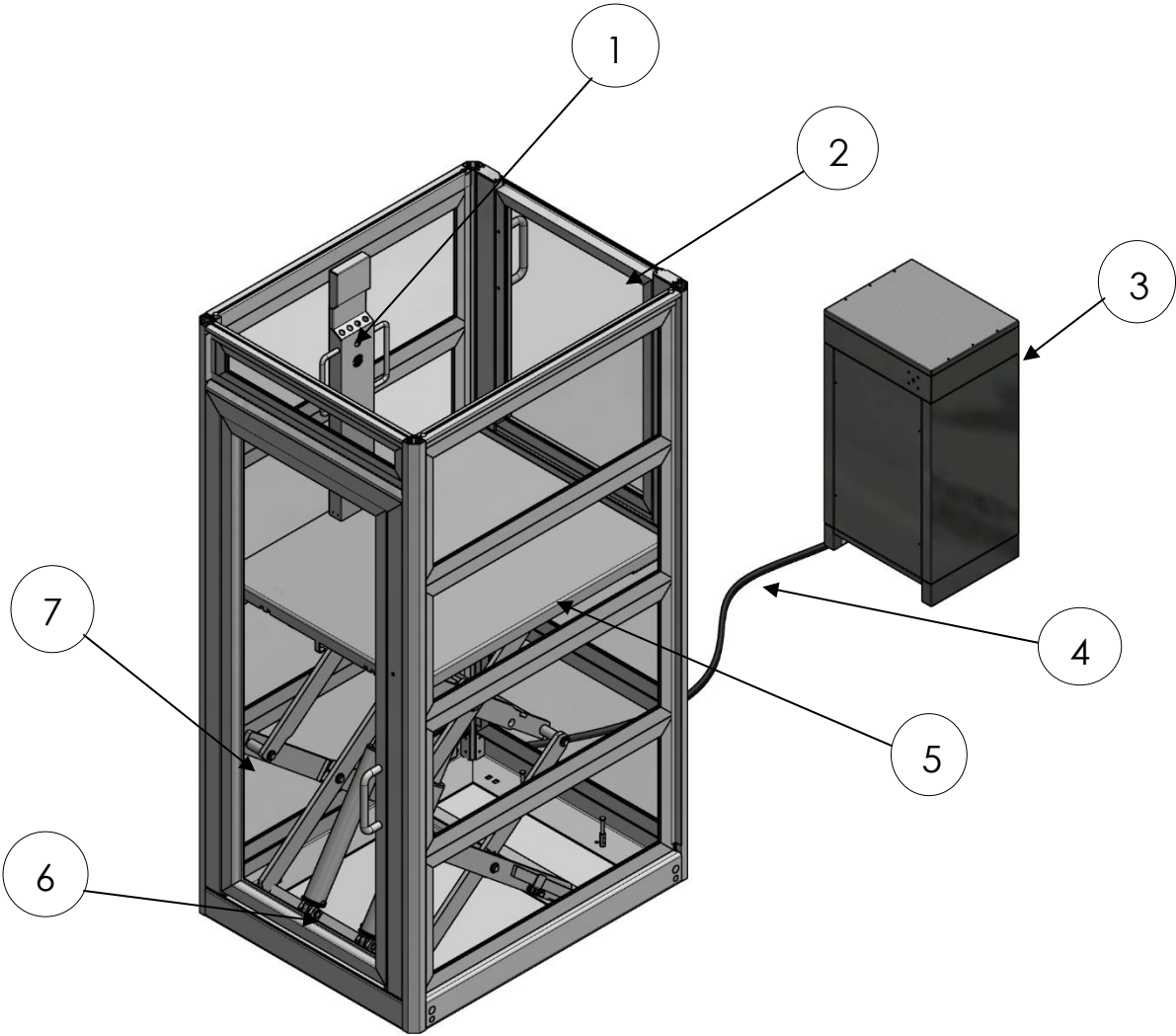

## Description

- 1. Cabin Operation Panel (COP)
- 2. Door - Height 1100mm
- 3. Cabinet
- 4. Rubber Hose
- 5. Scissor Platform
- 6. Hydraulic Cylinders
- 7. Door - Height max 2200mm

## 2. Specifications

<b>Model</b>	<b>UN_893</b>
<b>Rated Load (kg)</b>	420
<b>Travel Height (mm)*</b>	Max 2500
<b>Stops</b>	2
<b>Platform clear minimum dimensions</b>	900 x 1200 mm
<b>Platform clear standard dimensions</b>	1100 x 1400 mm
<b>Platform clear maximum dimensions</b>	1300 x 1600 mm
<b>Speed</b>	0.06 m/sec
<b>Pit depth (mm)</b>	130
<b>Motor **</b>	2 Hp / 220 V
<b>Diameter of the hydraulic cylinder</b>	2 pieces $\Phi$ 60 x 50
<b>Standard Finish (NEOKEM AMMOS)</b>	9016, 1013, 7040, 7016

\* Depends on platform dimensions.

\*\* Motor can be changed to 3HP/380 V depends on your needs.

UN\_893

### 3. Safety features

- \* Overpressure valve
- \* Battery operated evacuation system (power failure evacuation)
- \* Hose break (in case of elastic tube fracture)
- \* Alarm
- \* Hold to run buttons
- \* Electromechanical locks

### 4. Attributes

- \* Anti – Slip floor
- \* Triplex glass covers
- \* Low profile

### 5. Additional Options

- \* Automatic doors
- \* Colours can be customized to your taste

UN\_893

6. Technical Designs

6.1. Minimum Dimensions 900 x 1200 mm

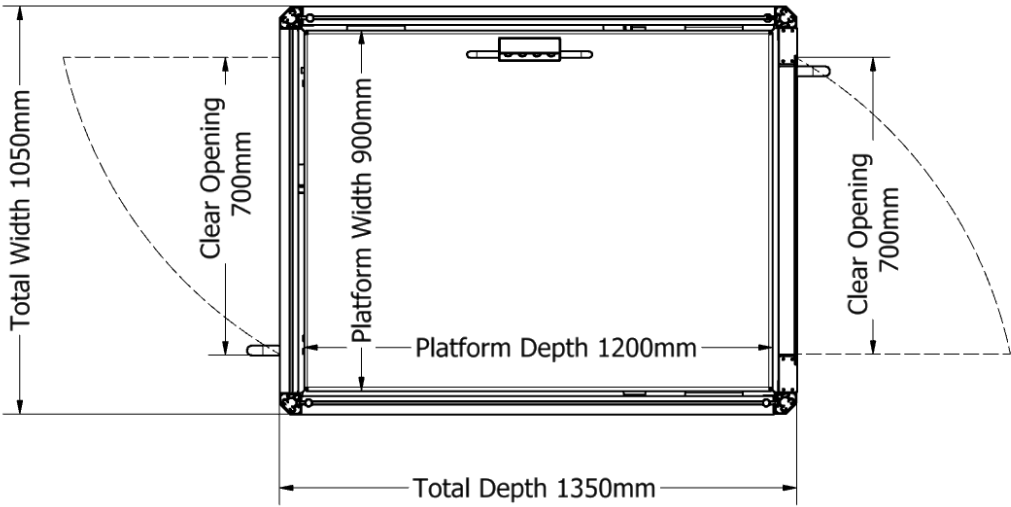
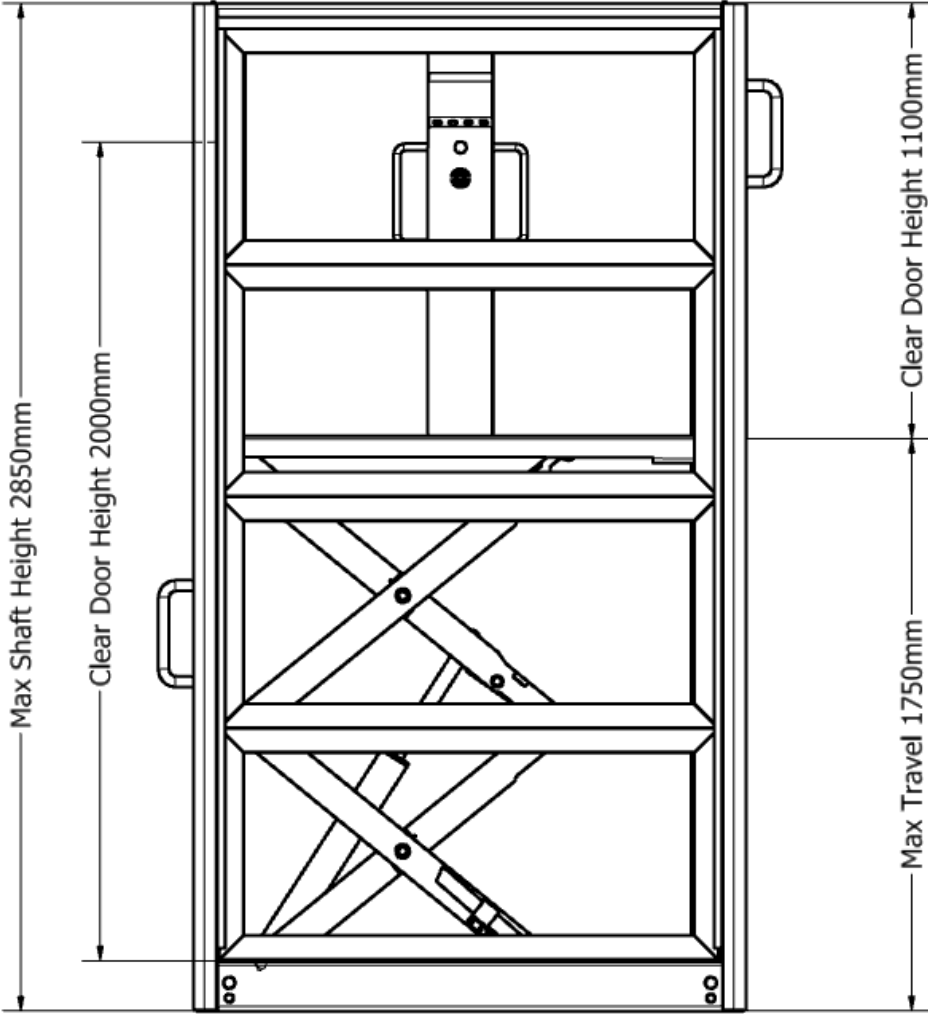

UN\_893

6.2. Standard Dimensions 1100 x 1400 mm

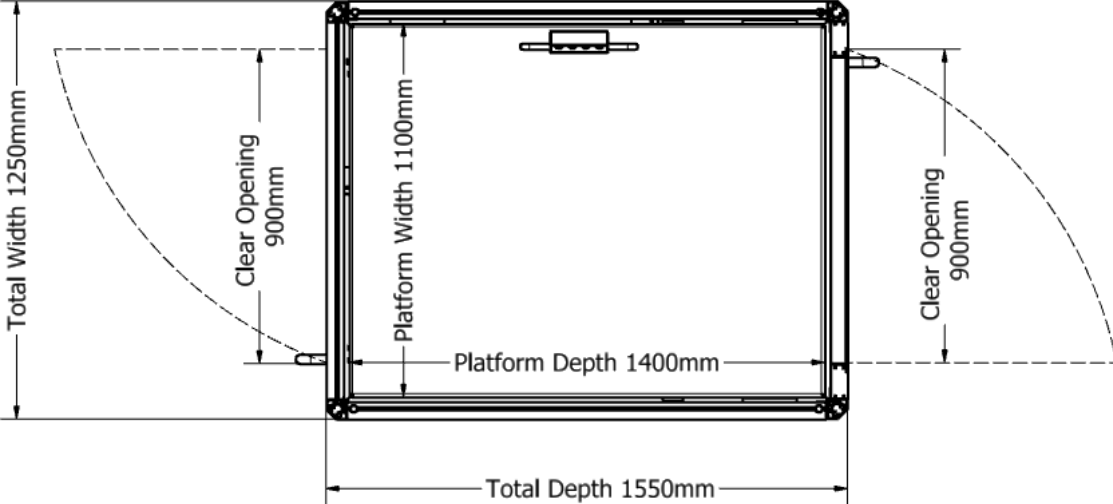
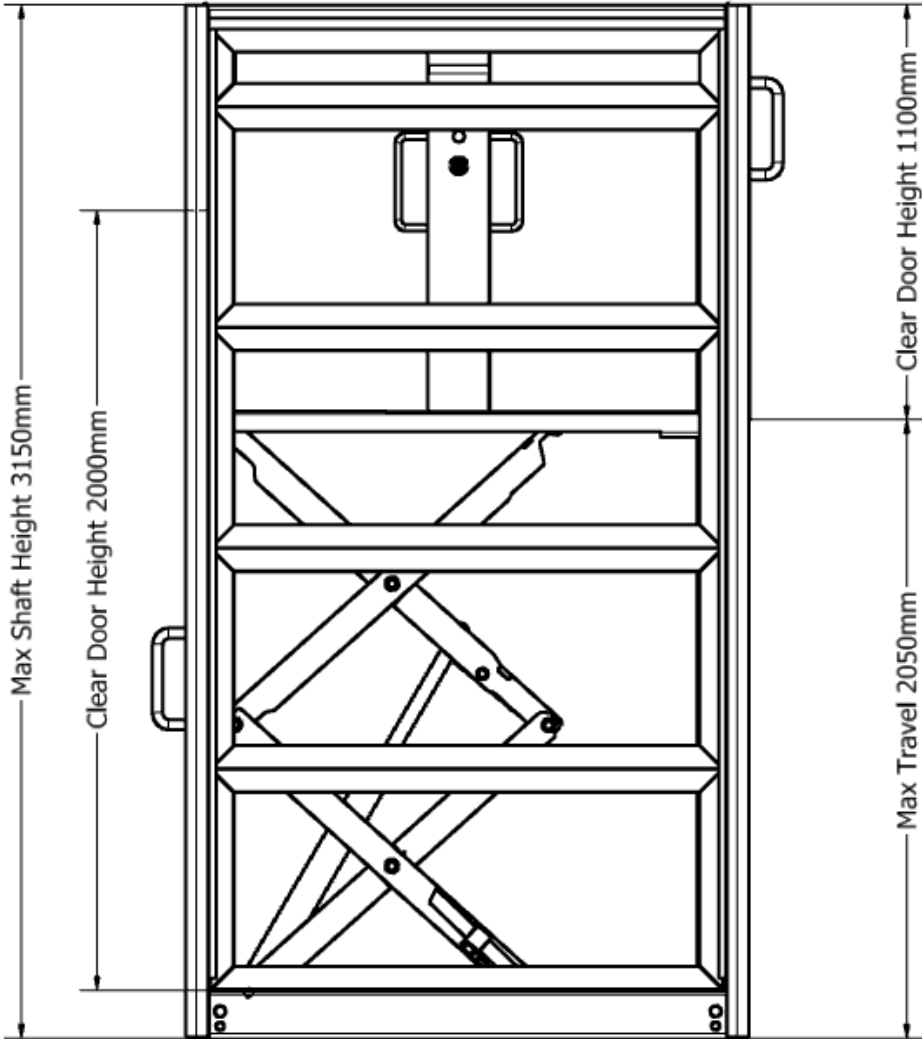

UN\_893

### 6.3. Max Dimensions 1300 x 1600 mm

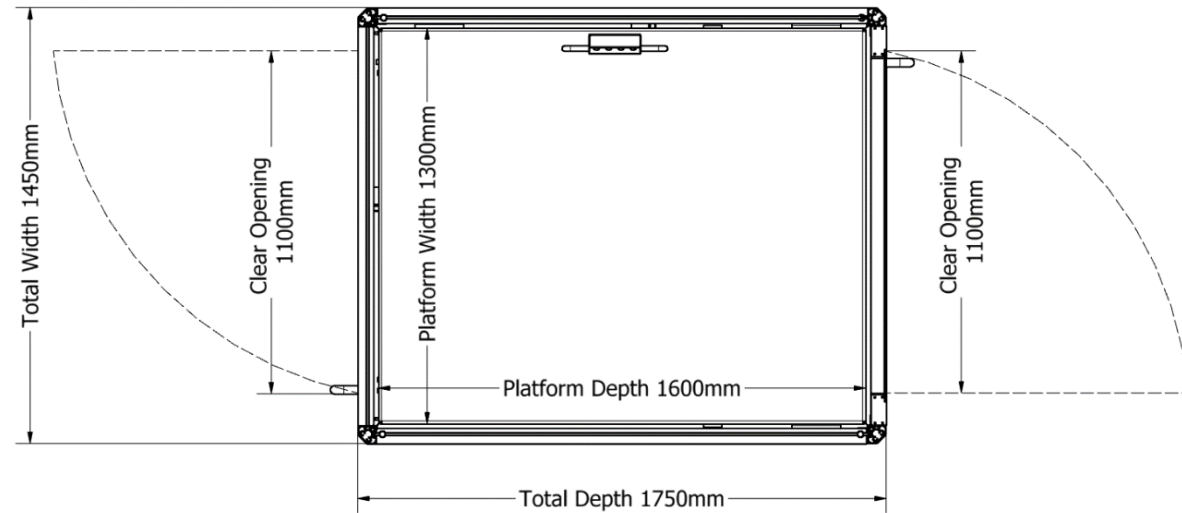
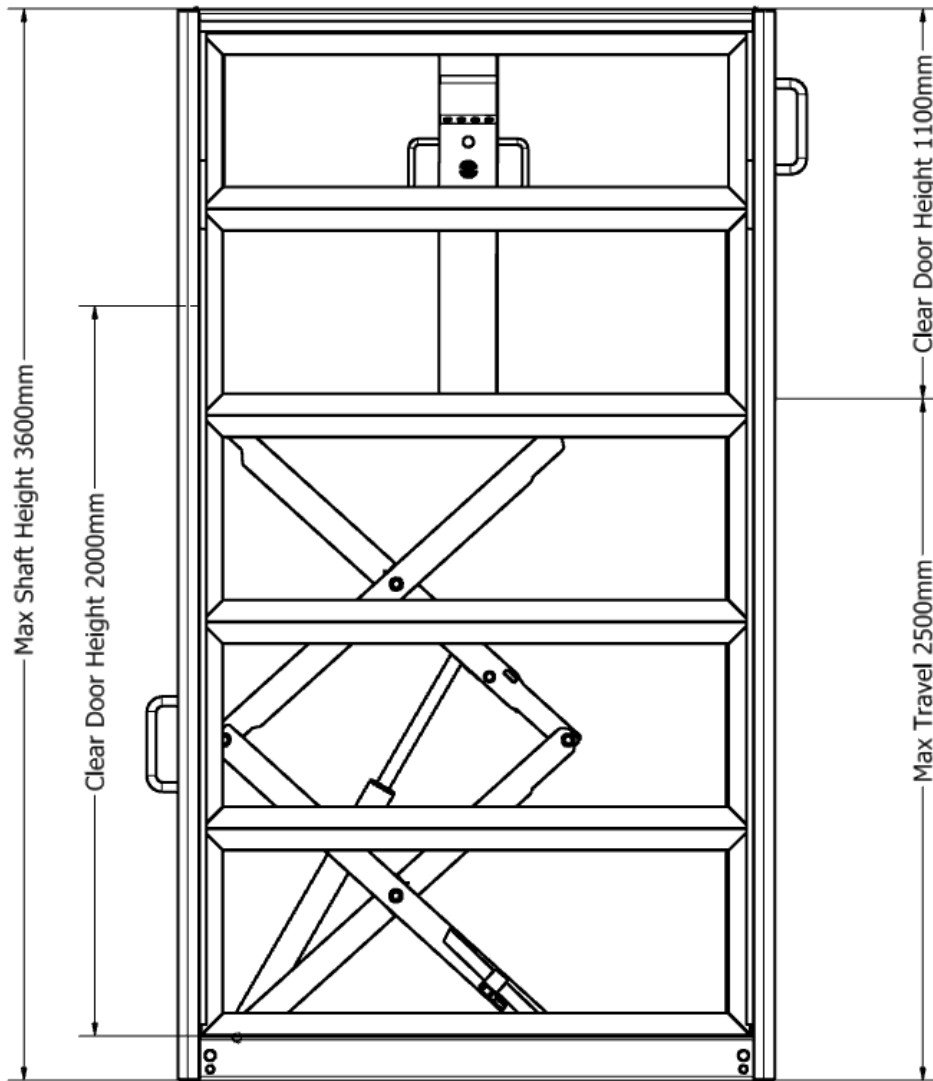



6.4. 90° Entrance – Exit 1100 x 1400 mm

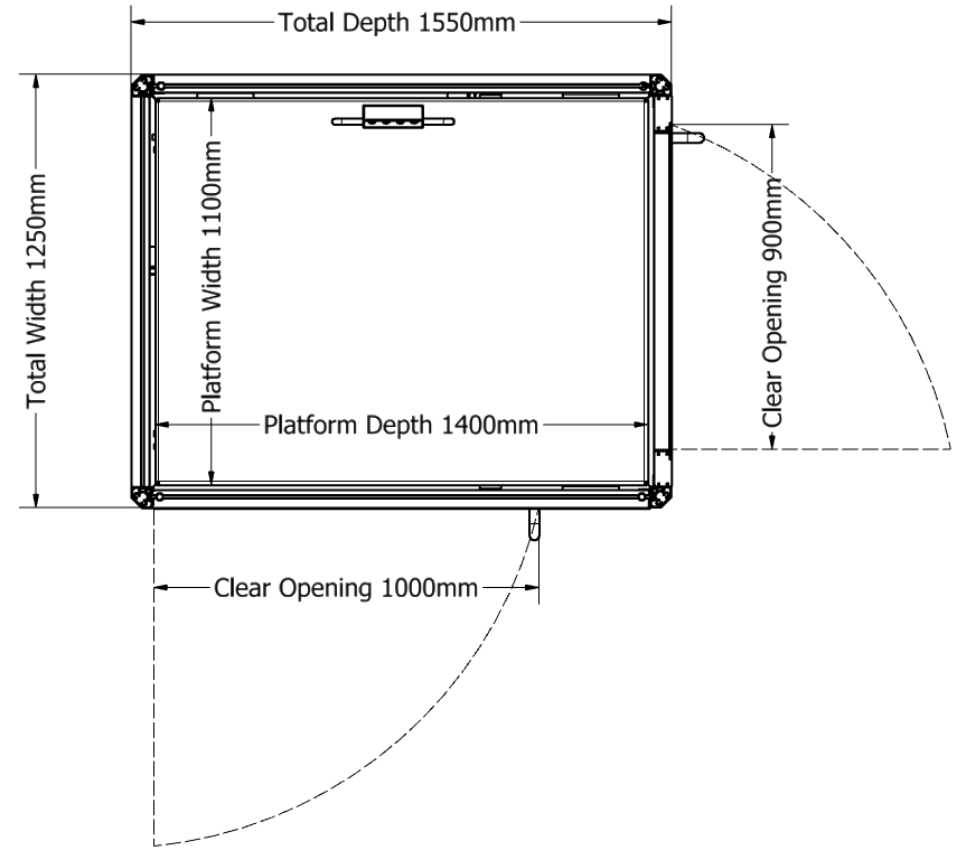
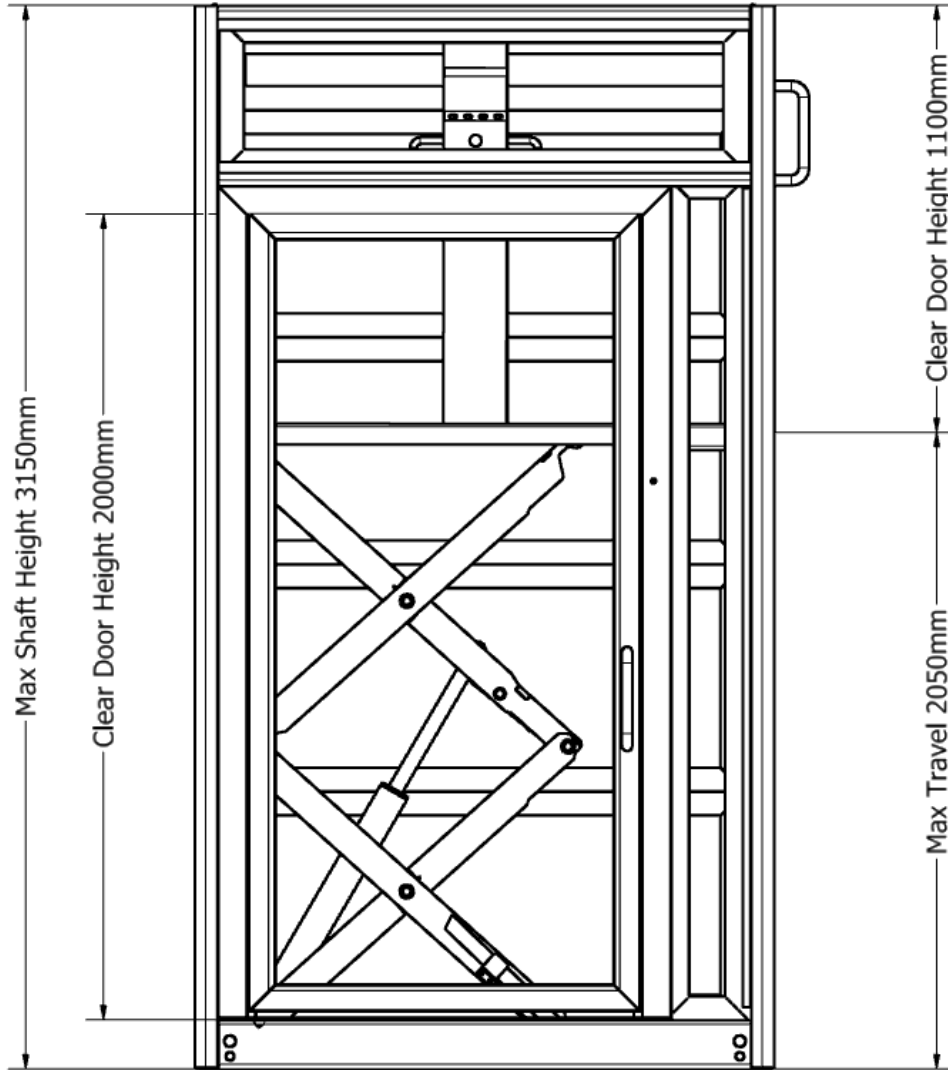

UN\_893

6.5 3 - d Representations

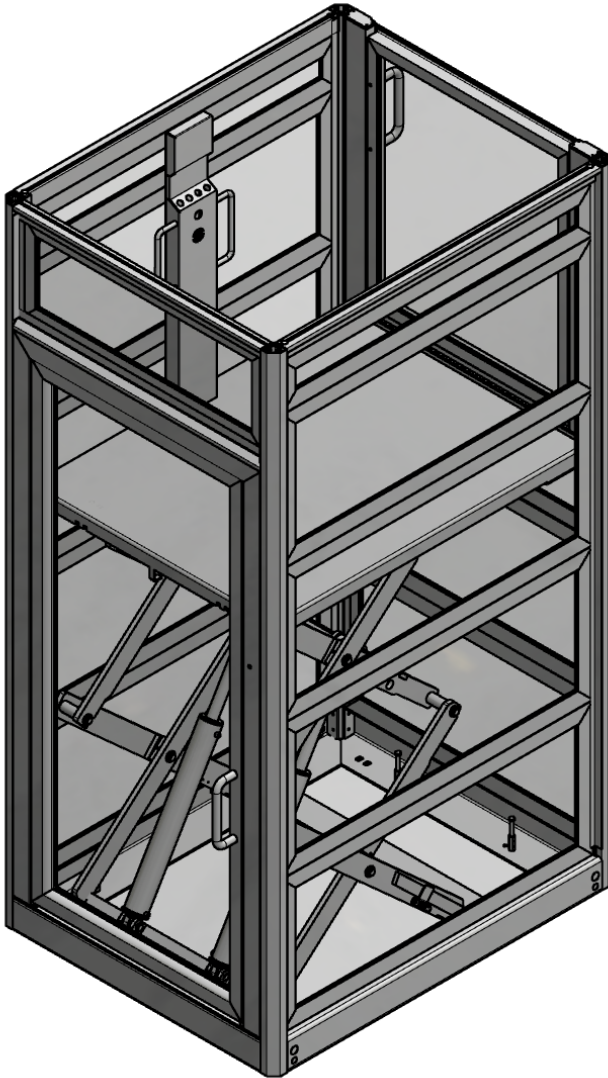

1 ENTRANCE - EXIT OPPOSITE SIDE

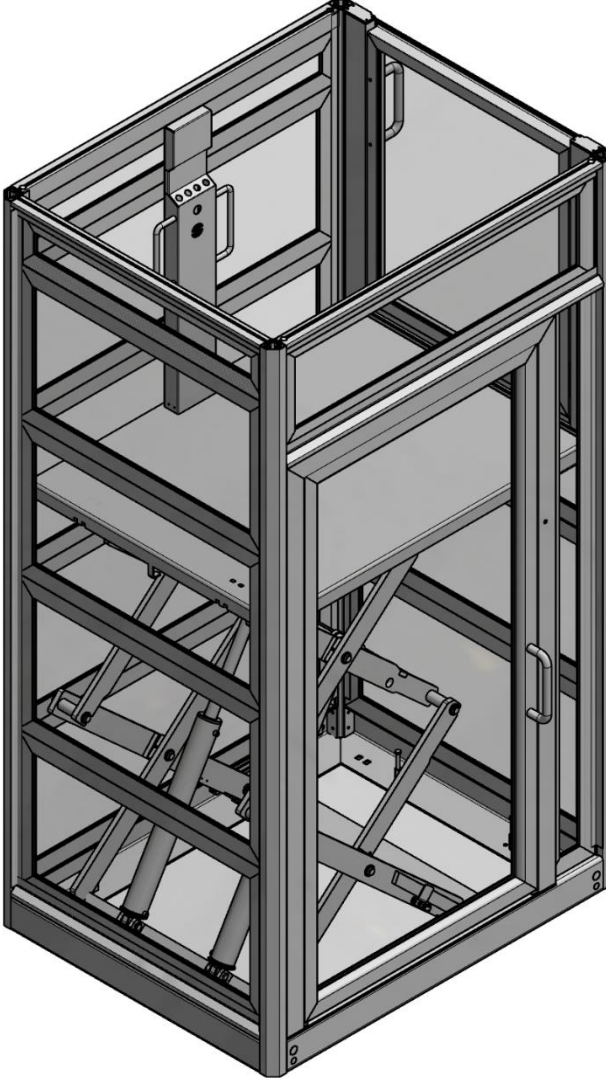

2 ENTRANCE - EXIT 90°

UN\_893

## 7. Dimensions of cabinet

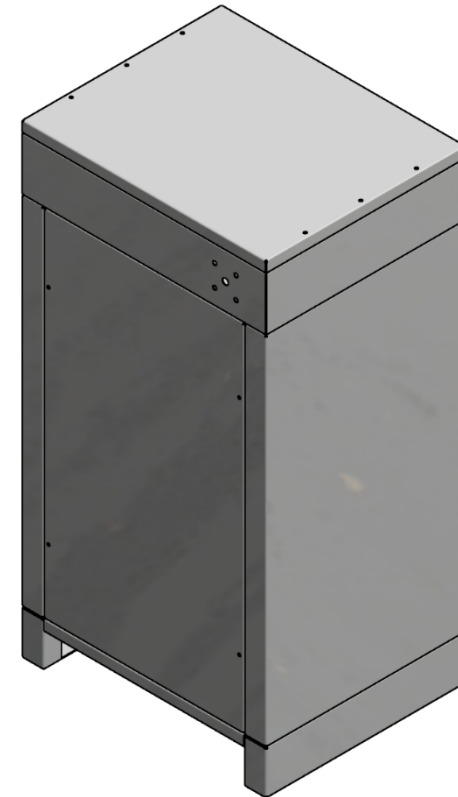
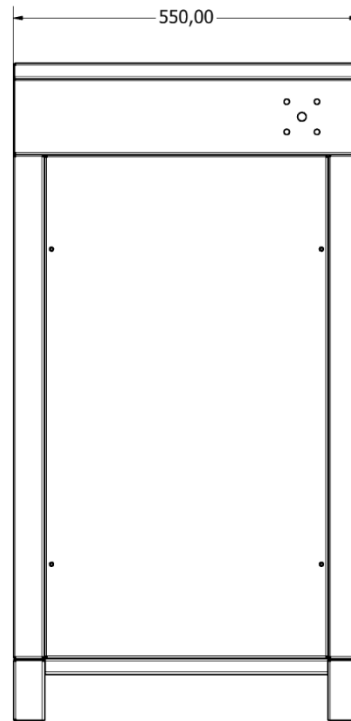
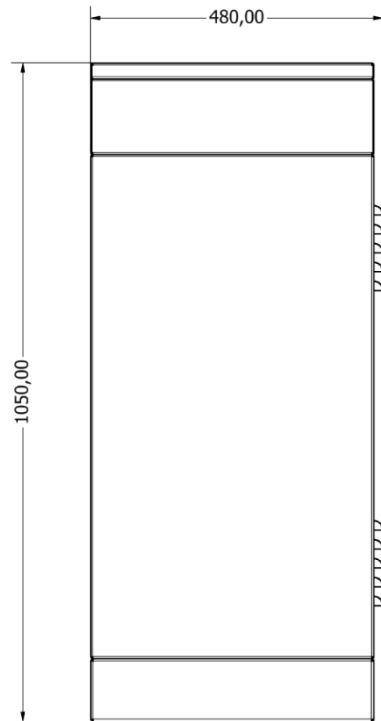

The Cabinet includes:

- Power Unit
- Control Panel